

RYOBI

CO-50

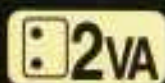
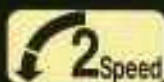
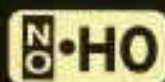
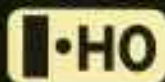

500,000
cycles

COU-50

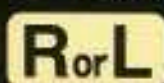
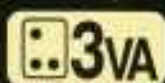
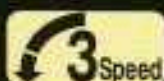
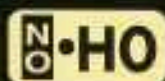

500,000
cycles



RYOBI

CO-50 COU-50

CONCEALED DOOR CLOSERS

RYOBI CONCEALED DOOR CLOSERS

CO-50 and COU-50

HIDDEN POWER

When the aesthetic appearance of the door is compromised by the need for a door closer, then the obvious choice is a concealed unit. Ryobi recognize that, due to the different sizes and weights of doors, the requirement is for a series of concealed closers designed to perform efficiently in each application. The solution is the CO-50 and COU-50 series: a complete range of concealed closers, covering size 2-6 doors, designed to be compact, durable and reliable, whatever the door specification.



To meet the necessity for a concealed closer to be ultra slim and yet withstand the high pressures generated in such a compact housing, the CO-50 and COU-50 series uses Ryobi's advanced R14 Aluminium Alloy Die-castings throughout the range. This high silicon alloy, developed by Ryobi for its automotive cylinder blocks, is unique in its exceptional strength and low friction properties.

Full hydraulic controls, the precision of a rack and pinion mechanism, together with the availability of speed controls and backcheck functions, the CO-50 and COU-50 series, provides the highest level of features built into a quality product, that will deliver a life long performance.

DOOR CLOSERS

WORLD CLASS TECHNOLOGY

Ryobi are the world's largest manufacturer of Aluminum die-castings and world leaders in door closer design. The CO-50 and COU-50 range of concealed door closers have been developed by utilizing the advanced design technology and highest standards of quality that only Ryobi can demonstrate. Combining the advanced R14 alloy and state of the art production methods, the CO-50 and COU-50 series is guaranteed to provide an unrivaled quality and a lifetime of trouble free service.



CONCEALED DOOR CLOSERS RYOBI CO-50

CO-50/COU-50 INSTALLATION OPTIONS

In order to ensure total adaptability to the widest range of applications, the concealed series is available with a choice of either standard or top jamb installations. To further enhance the ranges flexibility, options such as hold open and nonhanding for the CO-50 are also available.



EXCEPTIONAL PERFORMANCE-EXCEPTIONAL VALUE

Ryobi's technology in high quality die-casting and advanced production methods have been combined to produce a highly competitive range of performance closers. In-house tested to 500,000 cycles and incorporating precision rack and pinion mechanisms, the concealed closer range offers outstanding quality and performance at a very realistic price.

FULLY HYDRAULIC CONTROLS

Maximum control over the doors closing speed is provided by the easy to operate hydraulic adjustment, whilst the versatile hydraulic mechanism also allows for 1st and 2nd closing (as illustrated), ensuring a smooth and independent control over the doors movement. The added benefit of a latching speed control is available with the COU-50 series and CO-55,56, whilst for the heavy duty CO-55 and 56 a new adjustable hydraulic backcheck function is a significant feature.

Speed adjustment valve

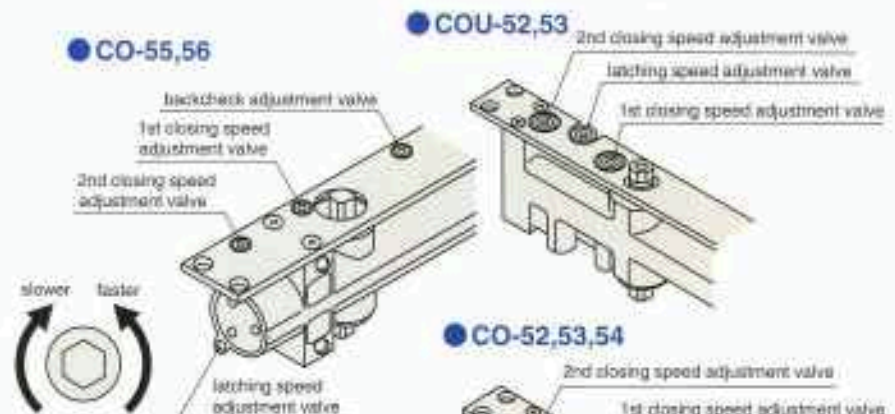
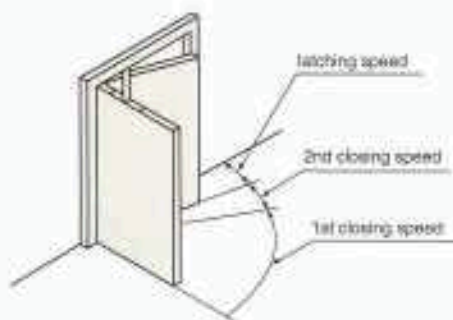

NEW MECHANICAL BACKCHECK FUNCTION

Available for all models in the series, the new mechanical backcheck (cushion check) function, features setting and adjustment in the guide rail. The cushioned rubber absorbs the power of the door in the event of it violently swinging open, as in the case of high winds or public misuse.

The backcheck facility reduces the possibility of door damage and is particularly important in public buildings, schools and hospitals where the protection of people and property is paramount.

Note: CO-55,56 have hydraulic backcheck function.

Mechanical backcheck function is not necessary for CO-55,56.



COU-50

ADJUSTABLE DOOR STOP/HOLD OPEN/BACKCHECK ANGLE & HOLD OPEN FORCE

By the positioning of stopper, stop metal fitting (hold open device), and mechanical backcheck device, the door stop angle, hold open angle and backcheck angle are adjustable as required. Hold open force is also adjustable by the hold open force adjustment nut as shown in the chart.

Adjustment of door stop/hold open/backcheck angle

Door stop/Hold open/backcheck angle are adjustable by the positioning of stopper/stop metal fitting (hold open device), and mechanical backcheck device at ①~⑥ as shown in illustration.

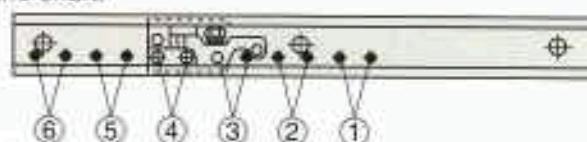

Positioning of stopper/stop metal fitting/backcheck device
*This illustration shows the positioning of stop metal fitting (hold open device) at ④. Please see each drawings for the details.

Adjustment of hold open force

Hold open force is adjustable by the hold open force adjustment nut.

Model	Adjustable range(kg-m)
CO/COU-152	0~3.6
CO/COU-153	0~3.1
CO-154	0~2.7
CO-155	0~3.7
CO-156	0~1.5

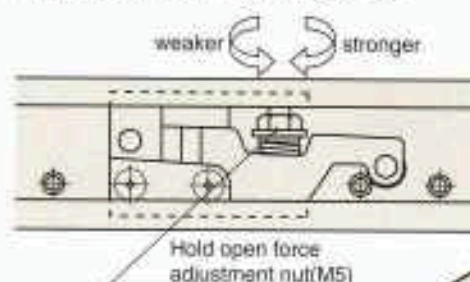

PARTS AND ACCESSORIES

No.	Name of Parts and Accessories		
1	Body		
2	Mounting plate		
3	Arm		
4	Guide rail		
5	Slider		
6	6-A	6-B	6-C
	Stopper (for "Without hold open")	Stop metal fitting (for "With hold open")	Backcheck device (for "Mechanical backcheck")
7	⊕ Flat head machine screw (With M4 head)(M5 L=12-2pcs)		
8	CO52-54, COU52,53	CO55,56	
	⊕ Flat head machine screw (With M4 head) (M5, L=12)	⊕ Flat head machine screw (#10-24UNC L=3/8")	
9	Washer		
10	⊕ Flat head machine screw (With M4 head)(M5, L=12 - 5pcs)		
11	⊕ Flat head tapping screw (φ4, L=25 - 5pcs)		
12	CO52-54, COU52,53	CO55,56	
	⊕ Flat head machine screw (M5, L=12-4pcs)	⊕ Flat head machine screw (M6, L=12-4pcs)	
13	⊕ Flat head machine screw (M5, L=12-4pcs)	⊕ Flat head machine screw (M6, L=16-4pcs)	
14	⊕ Flat head machine screw (φ5, L=30-4pcs)		

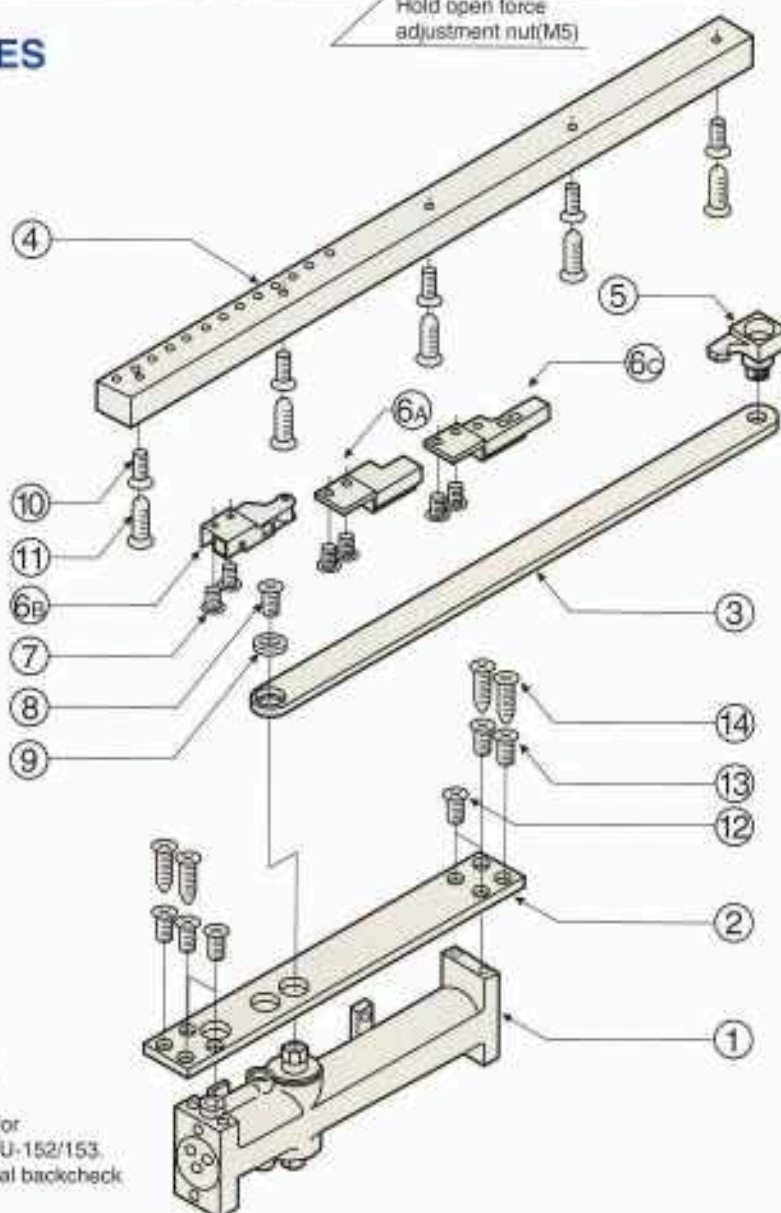

- Stopper 6-A is equipped for "without hold open type", CO-52/53/54/55/56 & COU-52/53/52H/53H.
- Stop metal fitting 6-B (hold open device) is equipped for "with hold open type", CO-152/153/154/155/156 & COU-152/153.
- Backcheck device 6-C is equipped for "with mechanical backcheck type", CO-52BC/53BC/54BC & COU-52BC/53BC.

CONCEALED DOOR CLOSERS RYOBI CO-50

MODEL CHART

Model Number			Max door dimensions	Max door weight	Door thickness				Body thickness
					Steel door		Wooden door		
Without hold open	With hold open	With Backcheck							
CO-52	CO-152	CO-52BC	900×2100	45kg	≥40mm	≥38mm	≥45mm	≥43mm	31mm
CO-53	CO-153	CO-53BC	950×2100	65kg	≥48mm	≥38mm	≥50mm	≥43mm	36mm
CO-54	CO-154	CO-54BC	1050×2400	85kg					36mm
CO-55 R	CO-155 R	-	1200×2400	120kg	≥60mm	≥60mm	≥65mm	≥60mm	48mm
CO-55 L	CO-155 L	-							48mm
CO-56 R	CO-156 R	-	1800×2700	180kg	≥60mm	≥60mm	≥65mm	≥60mm	48mm
CO-56 L	CO-156 L	-							48mm

Note: Hydraulic backcheck function is standard function for CO-55 & 56.

Door cut dimension

CO-52 / 152 / 52BC

CO-53,54 / 153,154 / 53BC,54BC

CO-55,56 / 155,156

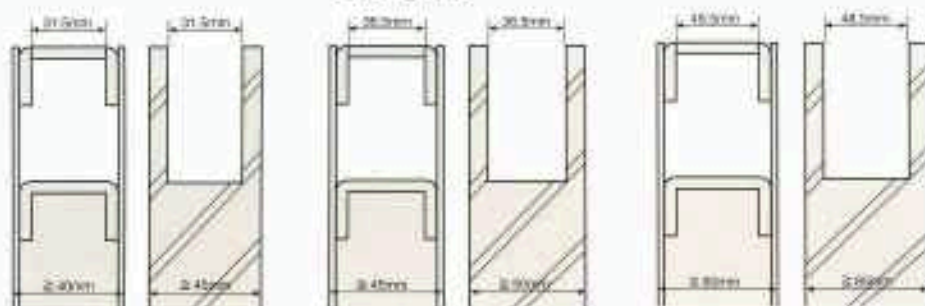

Drawing for CO-52

- The drawing shows right opening door.
- This item is suitable both for right opening and left opening table.

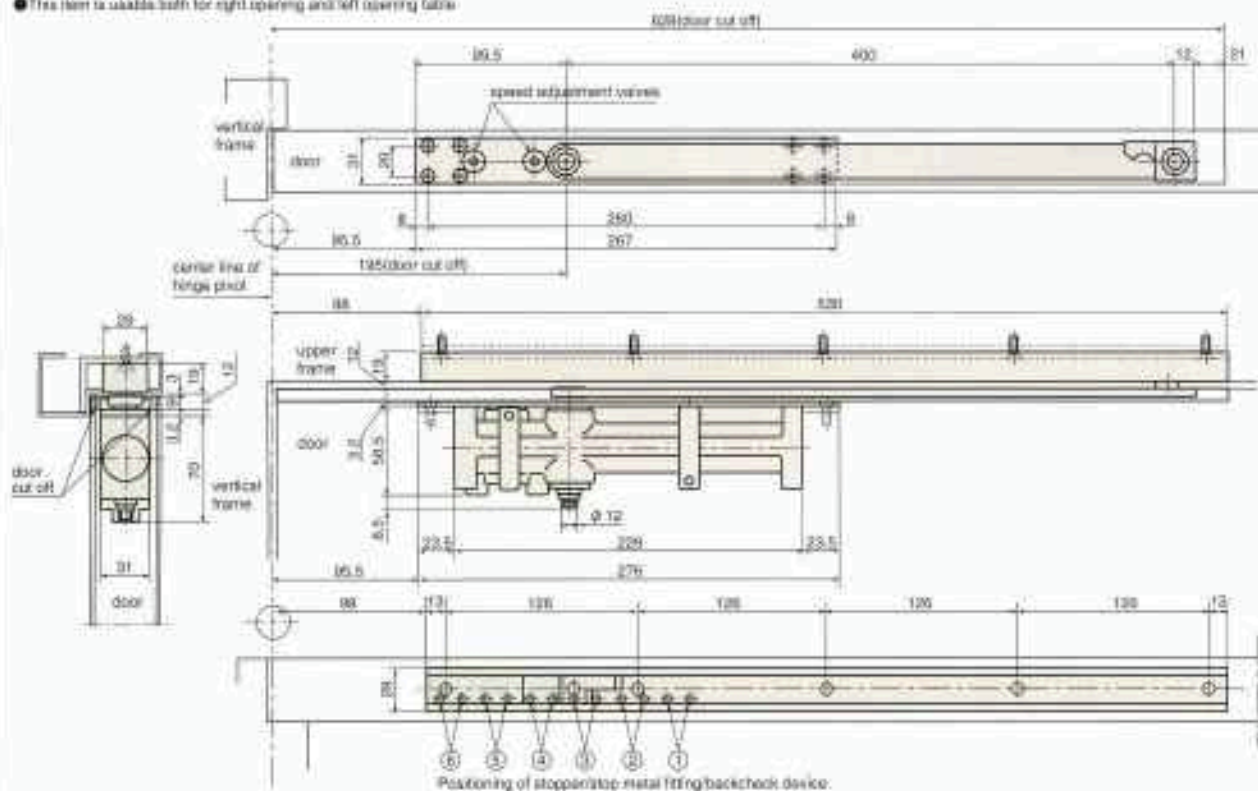

	Angle of door stop / hold open / backcheck					
Installation position	(1)	(2)	(3)	(4)	(5)	(6)
180° opening	100°	100°	119°	133°	155°	180°

Drawing for CO-53,54

- The drawing shows right opening door
- This item is suitable both for right opening and left opening table

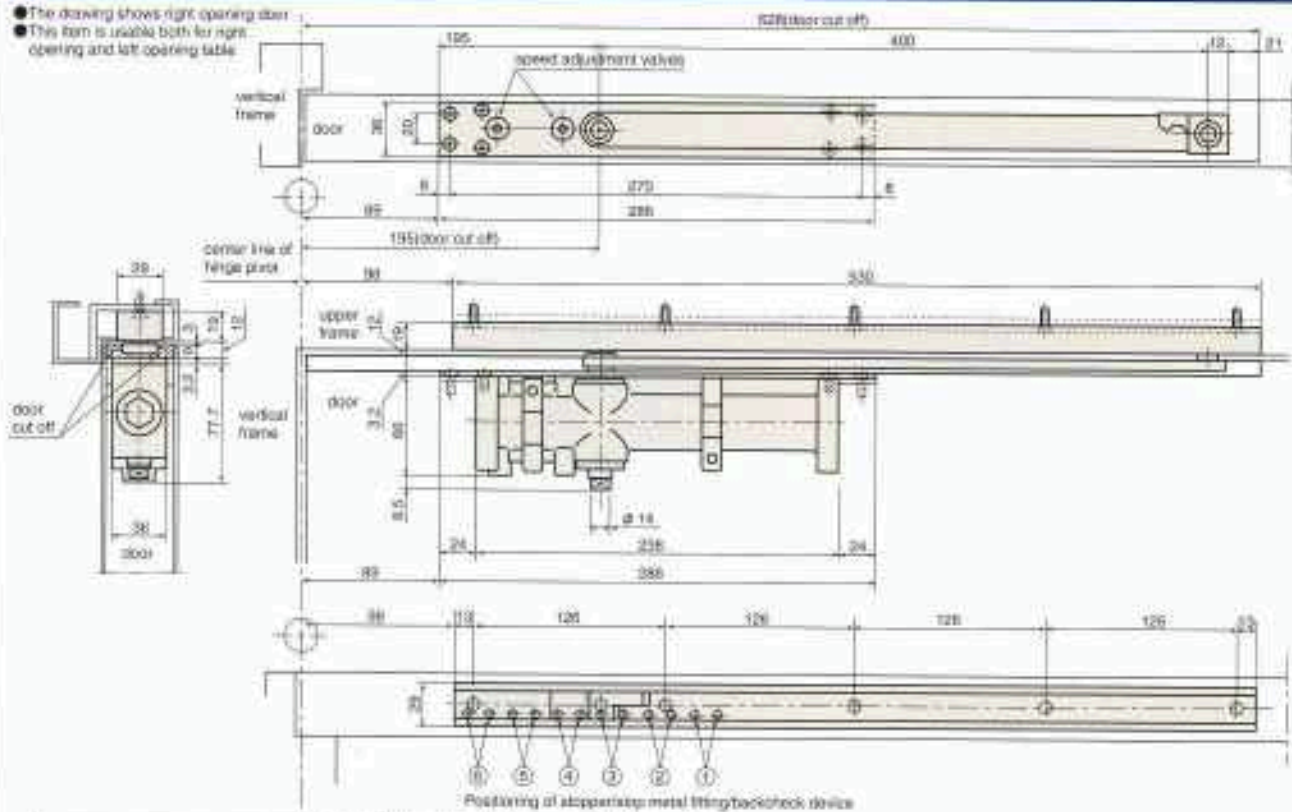

Installation position	Angle of door stop / hold open / backcheck					
	(1)	(2)	(3)	(4)	(5)	(6)
180° opening	100°	109°	119°	135°	155°	180°

Drawing for CO-55, 56

- The drawing shows right opening door

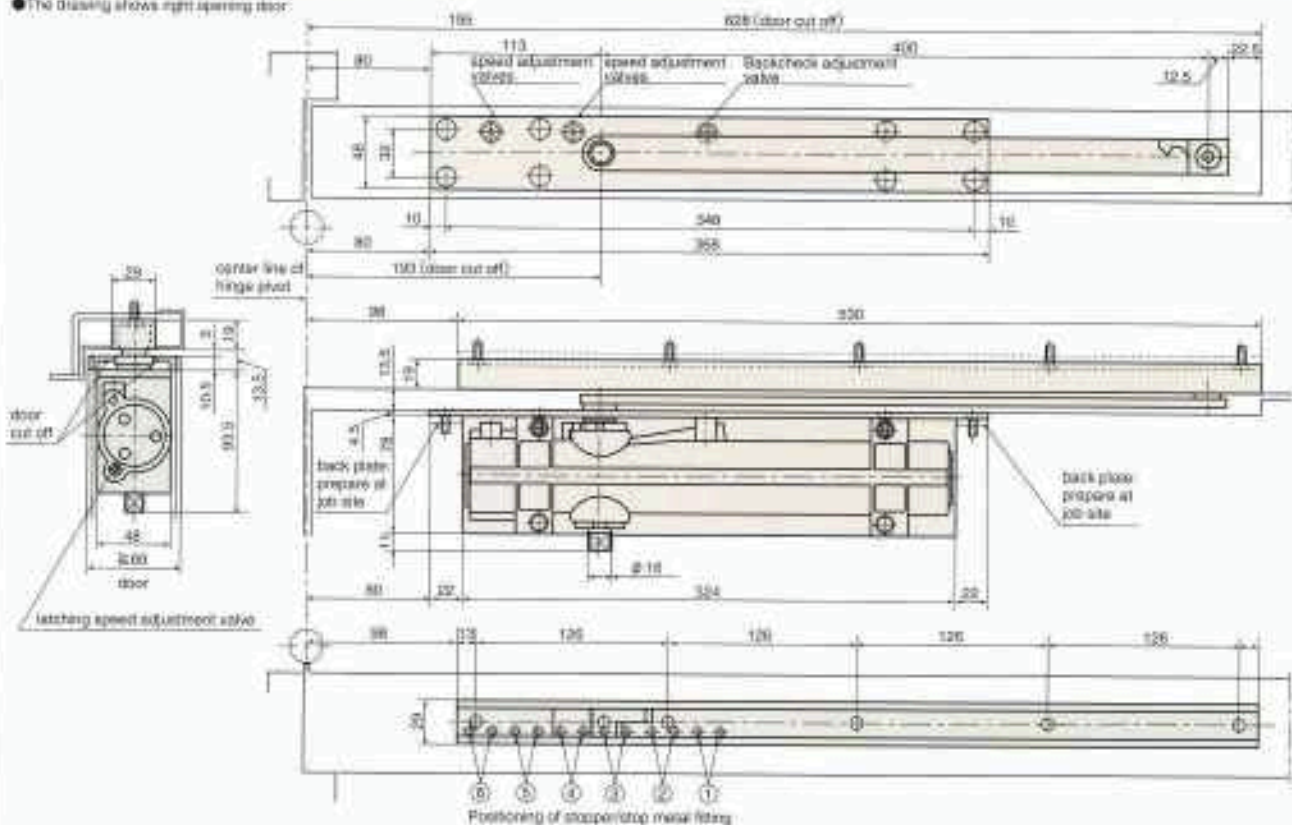

Installation position	Angle of door stop					
	(1)	(2)	(3)	(4)	(5)	(6)
180° opening	100°	109°	118°	131°	151°	180°

Installation position	Angle of hold open					
	(1)	(2)	(3)	(4)	(5)	(6)
100° opening	100°	109°	118°	131°	151°	-

CONCEALED DOOR CLOSERS **RYOBI COU-50**

MODEL CHART

Model Number			Max door dimensions	Max door weight	Door thickness				Body thickness
Without hold open	With hold open	With Backcheck			Steel door		Wooden door		
					Standard installation	Top jamb installation	Standard installation	Top jamb installation	
COU-52 R	COU-152 R	COU-52BC R	900 × 2100	45kg	≥ 36mm	≥ 36mm	≥ 40mm	≥ 40mm	28mm
COU-52 L	COU-152 L	COU-52BC L							28mm
COU-53 R	COU-153 R	COU-53BC R	950 × 2100	65kg	≥ 36mm	≥ 36mm	≥ 40mm	≥ 40mm	28mm
COU-53 L	COU-153 L	COU-53BC L							28mm
COU-52H R			900 × 2100	45kg	≥ 36mm	≥ 36mm	≥ 40mm	≥ 35mm	28mm
COU-52H L									28mm
COU-53H R			950 × 2100	65kg	≥ 36mm	≥ 36mm	≥ 40mm	≥ 35mm	28mm
COU-53H L									28mm

- Door cut dimension
COU-52,53 / 152,153
COU-52H,53H / 52BC,53BC

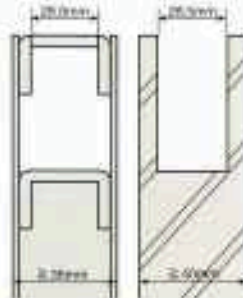

Drawing for COU-52/53, 52H/53H

The drawing shows right opening door

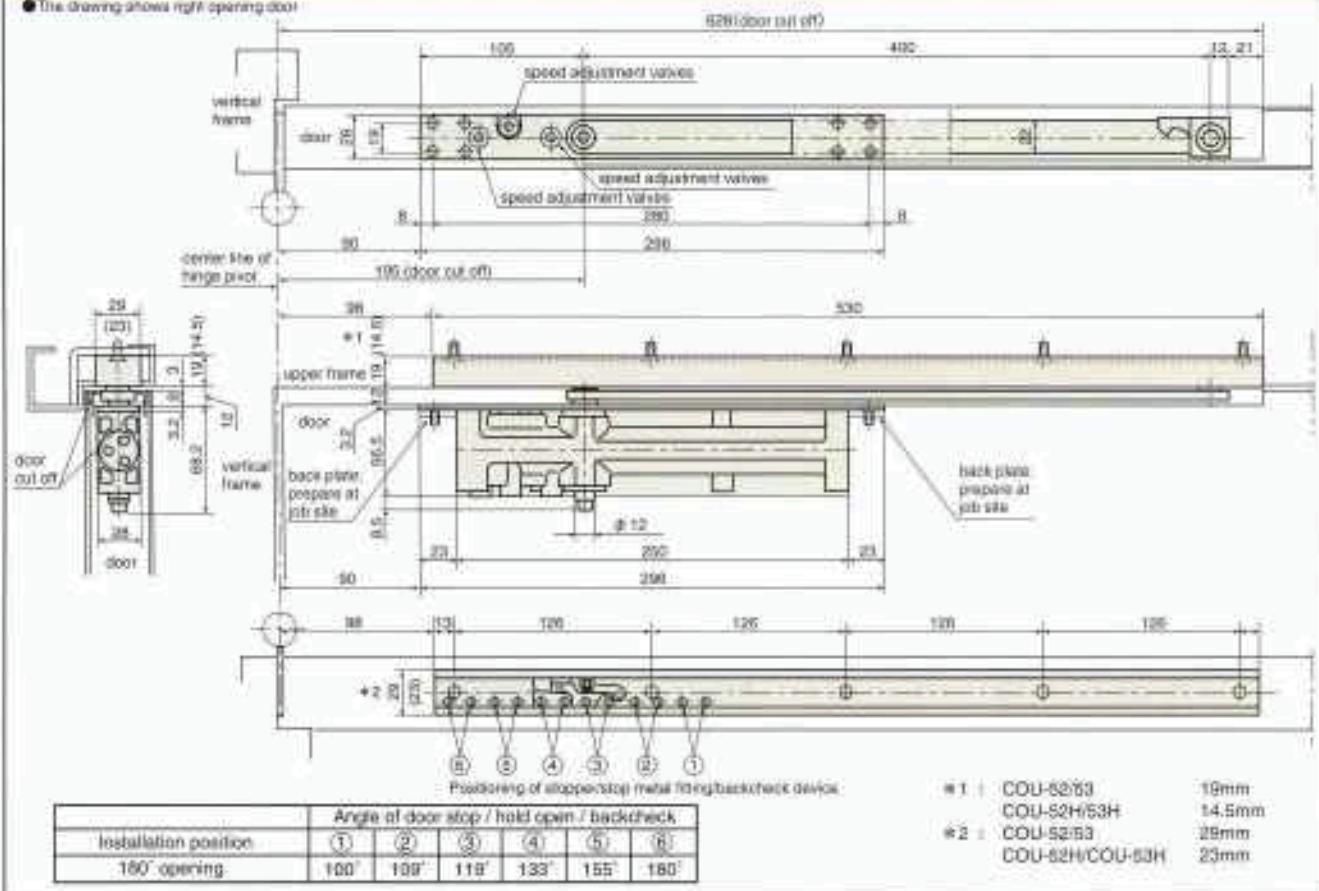

DISTRIBUTED BY

RYOBI LIMITED

5-2-8 Toshima, Kita-ku Tokyo 114-8518, Japan
Tel. 81-3-3927-5536 Fax. 81-3-3927-5527

RYOBI is a registered trade mark of Ryobi Limited