



## FITTINGS TO HELP THE LESS ABLE



*Although our range can be accurately described as user friendly, we have developed a suite of products specifically to assist the disabled, including extended bathroom turns which are easy to grip. Our specially extended lever handle is easy to operate with elbows, but safely returns to the door, to avoid catching clothing, particularly sleeves and pockets. As with most of our range, we can produce special items to compliment our standard fittings to help the less able, and our technical staff are always available to offer advice or review sketches / drawings of products to meet special needs.*

**Cranked Grab Rail**  
SS GBC1 PC GBC1

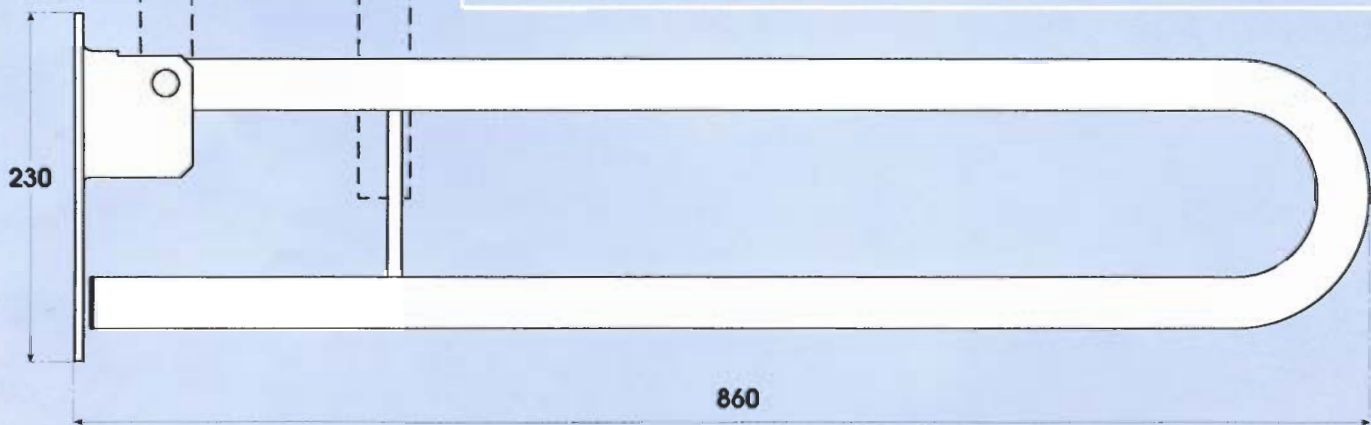
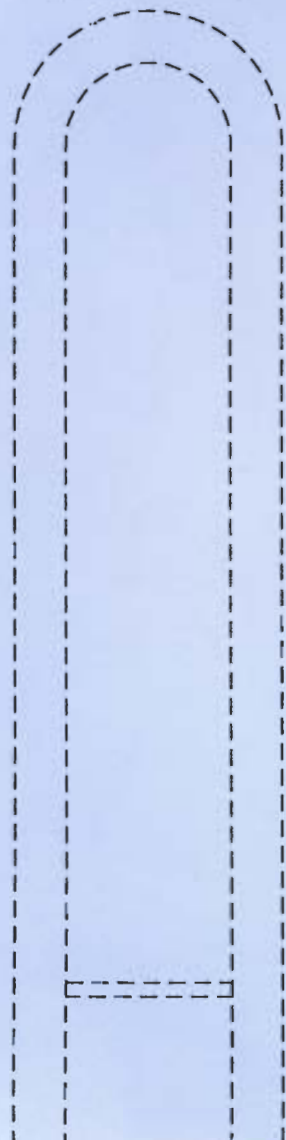
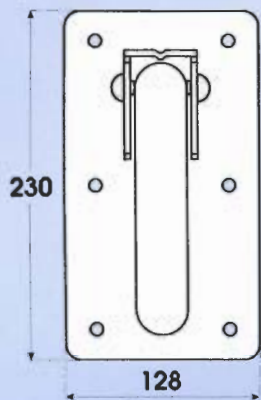

**Triple Bend Lever on Rose**

- AS D19RCR triple bend 19mm lever on rose
- AS D19RCH triple bend on concealed plate
- AS D19RCM triple bend 19mm lever on bathroom plate

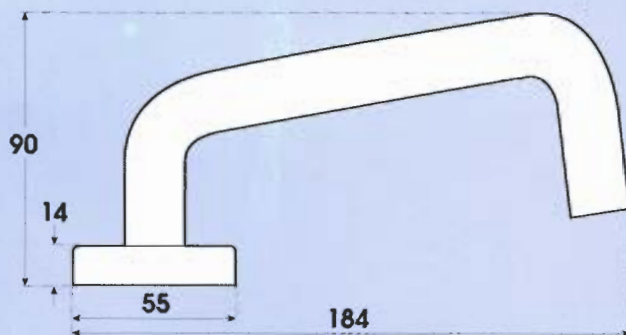

**Bathroom Indicators**

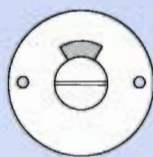

- AS DIFM 2
- SS DIFM 2
- PB DIFM 2

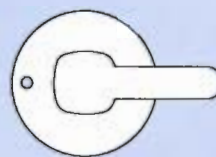

- AS DIFM 1
- SS DIFM 1
- PB DIFM 1

**Handrail Bracket**

- AS HRBE
- PB HRBE
- SS HRBE

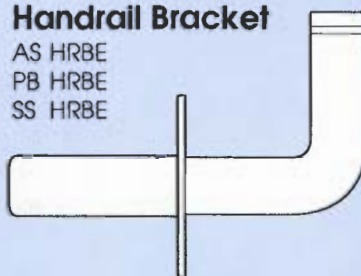

**Grab Rail / Towel Rail**

- SS GB1 / SS TR1
- PC GB1 / PC TR1



**Back Rest**  
SS BR1 PC BR1

